

# Chip-Type Metal Plate Low-Resistance Resistor

ISO 9001:2000  
CERTIFIED  
TS-16949  
CERTIFIED

## Type TLR

### 1. General

- Products with lead-free terminations meet RoHS requirements
- Metal alloy: superior corrosion & heat resistance
- Applications include current sensing, voltage division and pulse applications
- Ultra low resistance (1mΩ~20mΩ) suitable for large current detecting
- Ultra-low TCR (±75ppm/°C) available
- Low inductance

### 2. Type Designation

The type designation shall be the following form:

#### New Type

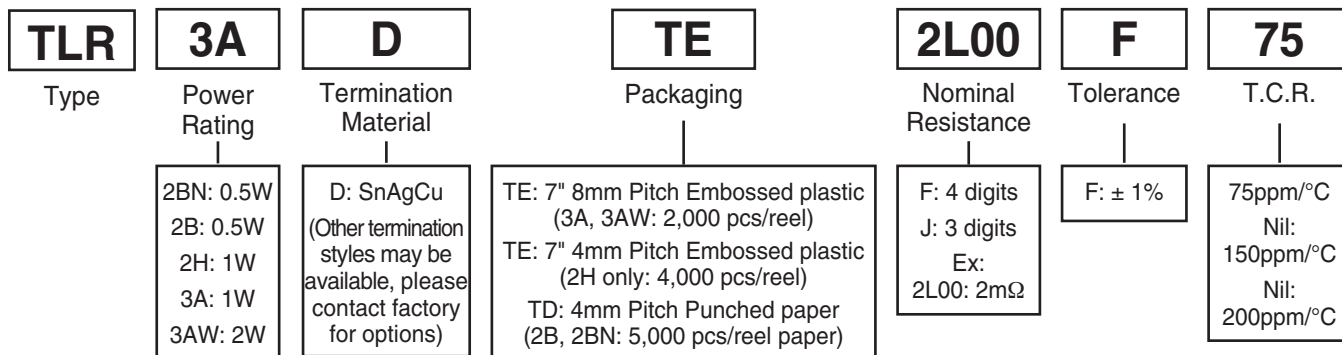

### 3. Standard Applications

Part Designation	Power Rating @ 70°C	T.C.R. (ppm/°C) Max.	Standard Resistance (Ω)	Resistance Tolerance	Absolute Maximum Working Voltage	Rated Ambient Temperature	Operating Temperature Range
TLR2BN	1/2W (.5W)	±150	2m,3m,4m,5m,6m,7m,8m,10m,11m,12m,13m,15m,16m,18m,20m	F: ±1%	$\sqrt{PxR}$	+70°C	-65°C to +155°C
TLR2B	1/2W (.5W)	±75	2m,3m,4m,5m,6m,8m,10m,11m,12m,13m,15m,16m,18m,20m	F: ±1%	$\sqrt{PxR}$	+70°C	-65°C to +155°C
TLR2H	1W	±75	1m,2m,3m,4m,5m,6m,7m,8m,9m,10m	F: ±1%	$\sqrt{PxR}$	+70°C	-65°C to +155°C
TLR3A	1W	±150	1m, 2m	F: ±1%	$\sqrt{PxR}$	+70°C	-65°C to +170°C
		±200	3m, 4m				
TLR3AW	2W	±75	2m,3m	F: ±1%	$\sqrt{PxR}$	+70°C	-65°C to +155°C
			4m,5m,6m,7m,8m				-65°C to +170°C
		±150	1m 9m,10m	F: ±1%			-65°C to +155°C -65°C to +170°C

## 4. Dimensions & Construction

2B, 2H and 3AW (2-8mΩ)

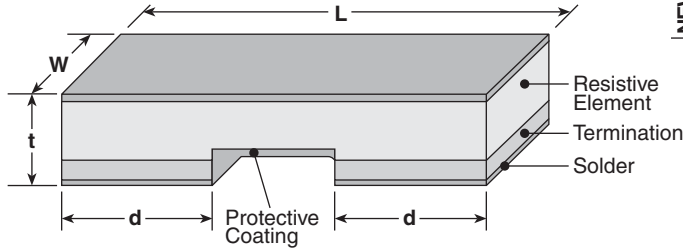

3AW (1mΩ)

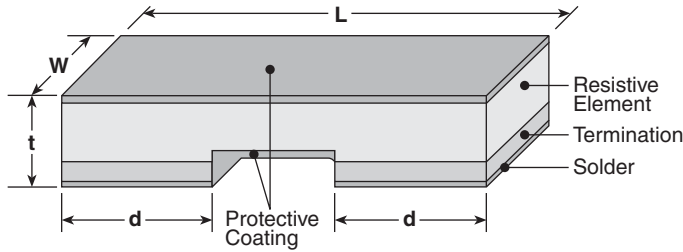

NEW	Size Code	Resistance	Dimensions inches (mm)			
			L	W	d	t
	TLR2BN	2m, 3m, 4m, 5m, 6m, 8m, 10m, 11m, 12m, 13m, 15m, 16m, 18m, 20m	.126±.008 (3.20±0.20)	.063±.008 (1.60±0.20)	.020±.008 (0.50±0.20)	.024±.008 (0.60±0.20)
	TLR2B					
	TLR2H	1mΩ			.071±.008 (1.80±0.20)	.026±.008 (0.65±0.20)
		2mΩ - 6mΩ	.200±.008 (5.00±0.20)	.100±.008 (2.50±0.20)	.060±.008 (1.50±0.20)	.024±.008 (0.60±0.20)
		7mΩ - 10mΩ			.020±.008 (0.50±0.20)	
	TLR3A	1mΩ			.087±.01 (2.20±0.25)	.024±.01 (0.62±0.25)
		2mΩ	.25±.01 (6.35±0.25)	.125±.01 (3.18±0.25)	.047±.01 (1.20±0.25)	
		3mΩ			.073±.01 (1.85±0.25)	
		4mΩ			.047±.01 (1.20±0.25)	
	TLR3AW	1mΩ - 4mΩ			.087±.01 (2.20±0.25)	.024±.01 (0.60±0.25)
		5mΩ - 8mΩ	.25±.01 (6.35±0.25)	.125±.01 (3.18±0.25)	.047±.01 (1.20±0.25)	
		9mΩ - 10mΩ			.030±.01 (0.77±0.25)	

## 5. Derating Curve

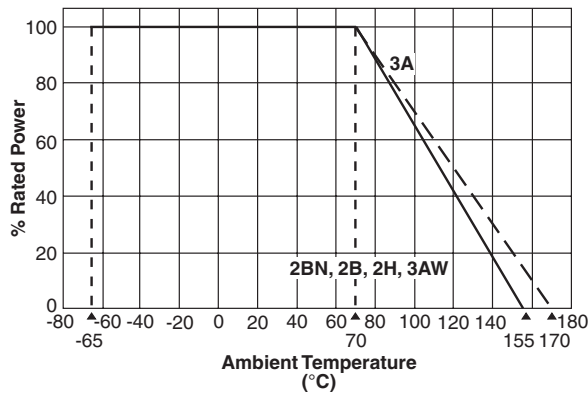

## 6. Temperature Rise

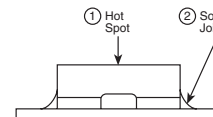
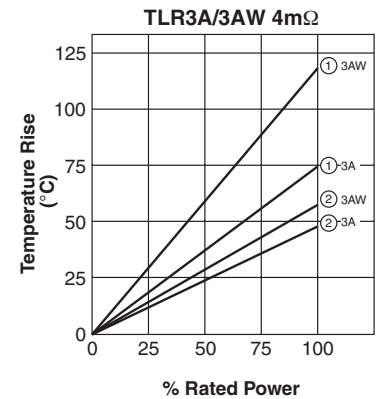
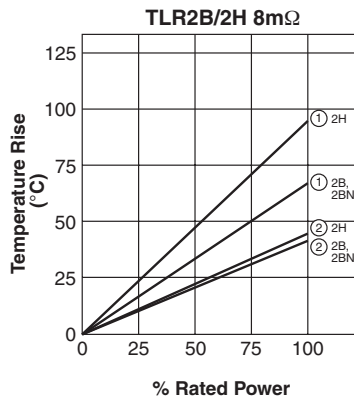

## 7. Characteristics

Item	Requirement	Conditions
Thermal Shock	±0.5%Δ R	-55°C ~ +150°C, 1000 cycles, 15 minutes at each extreme
Short Time Overload	±0.5%Δ R	Rated power x 5 for 5 seconds (TLR3AW (9-10 mΩ only) rated power x 2.5 for 5 seconds)
Low Temperature Storage	±0.5%Δ R	-65°C for 24 hours
High Temperature Exposure	±1.0%Δ R	+170°C, 1000 hours for 3A & 3AW (4-10 mΩ only) ±155°C, 1000 hours for 3AW (1-3 mΩ), 2B & 2H only)
Blased Humidity	±0.5%Δ R	+85°C ± 2°C, 85% RH, 10% Bias, 1000 hours
Mechanical Shock	±0.5%Δ R	100 grams for 11 milliseconds, 5 pulses
Vibration	±0.5%Δ R	Frequency varied 10 to 2000 Hz in one minute, 3 directions, 12 hours
Load Life	±1.0%Δ R	1000 hours @ rated power, +70°C, 1.5 hours "ON", 0.5 hours "OFF"
Resistance to Solder Heat	±0.5%Δ R	+260°C ± 5°C, 10 ~ 12 seconds
Moisture Resistance	±0.5%Δ R	MIL-STD-202, Method 106, 0% power, 7a and 7b not required

## 8. Solder Pad Dimensions

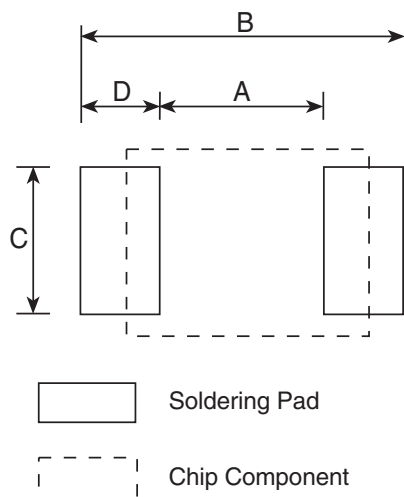

Type	Style	Dimensions millimeters				
		Component Size	A	B	C	D
TLR	2BN, 2B	3.2 X 1.6	1.4	4.0	1.8	1.3
	2H(1mΩ)	5.0 X 2.5	1.0	6.1	3.0	2.55
	2H (2mΩ-6mΩ)	5.0 X 2.5	1.3	6.1	3.0	2.4
	2H (7mΩ-8mΩ)	5.0 X 2.5	3.3	6.1	3.0	1.4
	3A(1mΩ)	6.35 X 3.18	1.45	7.55	3.83	3.05
	3A(2mΩ)	6.35 X 3.18	3.45	7.55	3.83	2.05
	3A(3mΩ)	6.35 X 3.18	2.45	7.55	3.83	2.70
	3A(4mΩ)	6.35 X 3.18	3.45	7.55	3.83	2.05
	3AW (1mΩ-4mΩ)	6.35 X 3.18	1.45	7.55	3.83	3.05
	3AW (5mΩ-8mΩ)	6.35 X 3.18	3.45	7.55	3.83	2.05
	3AW (9mΩ-10mΩ)	6.35 X 3.18	4.40	7.55	3.83	1.575

**10. Packaging**

**10.1 Dimensions of Carrier Tape**

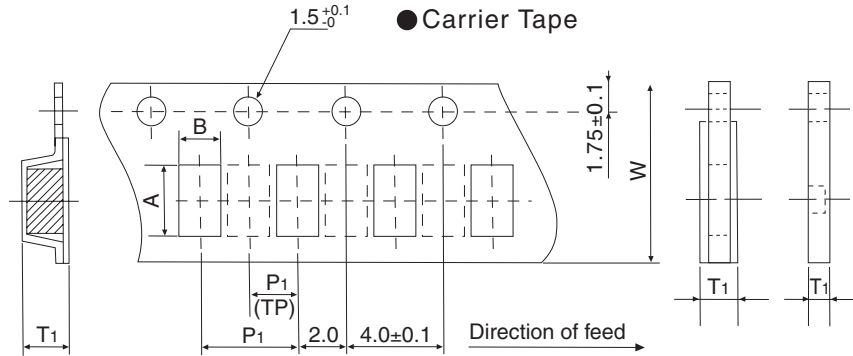

(Notes) Dotted lines are applicable to only "TP" and "TB."

Type	Component Size (mm)			Carrier Tape	Quantity/ Reel (Pieces)	Taping (mm)					Reel Size	
	L	W	T			A	B	W	P1	T1		
TLR	3A, 3AW	6.4	3.2	0.6	TE	2000	6.75±0.2	3.55±0.1	12.0±0.1	8.0±0.2	1.0±0.1	180
	2B, 2BN	3.2	1.6	0.6	TD	5000	3.5±0.2	2.0±0.2	8.0±0.2	4.0±0.1	0.75+0.2/-0	180
	2H	5.0	2.5	0.6	TE	4000	5.35±0.2	2.9±0.1	12.0±0.1	4.0±0.1	1.0±0.15	180

**10.2 Reel Dimensions (2,000 pieces/Reel)**

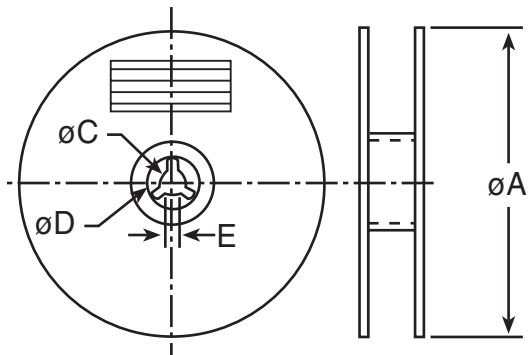

Dimensions in inches (mm)

	øA	øC	øD	E	Qty/ Reel
3A 3AW	7.08	.511	.826	.079	2,000
2B	(180 ± 0.0) 3.0	(13.0 ± 0.2)	(21.0 ± 0.8)	(2.0 ± 0.2)	5,000
2H					4,000